

# Air Flow Sheet

## Astro FR Ceiling Valve Supply

Revision 1 - 23rd February 2024

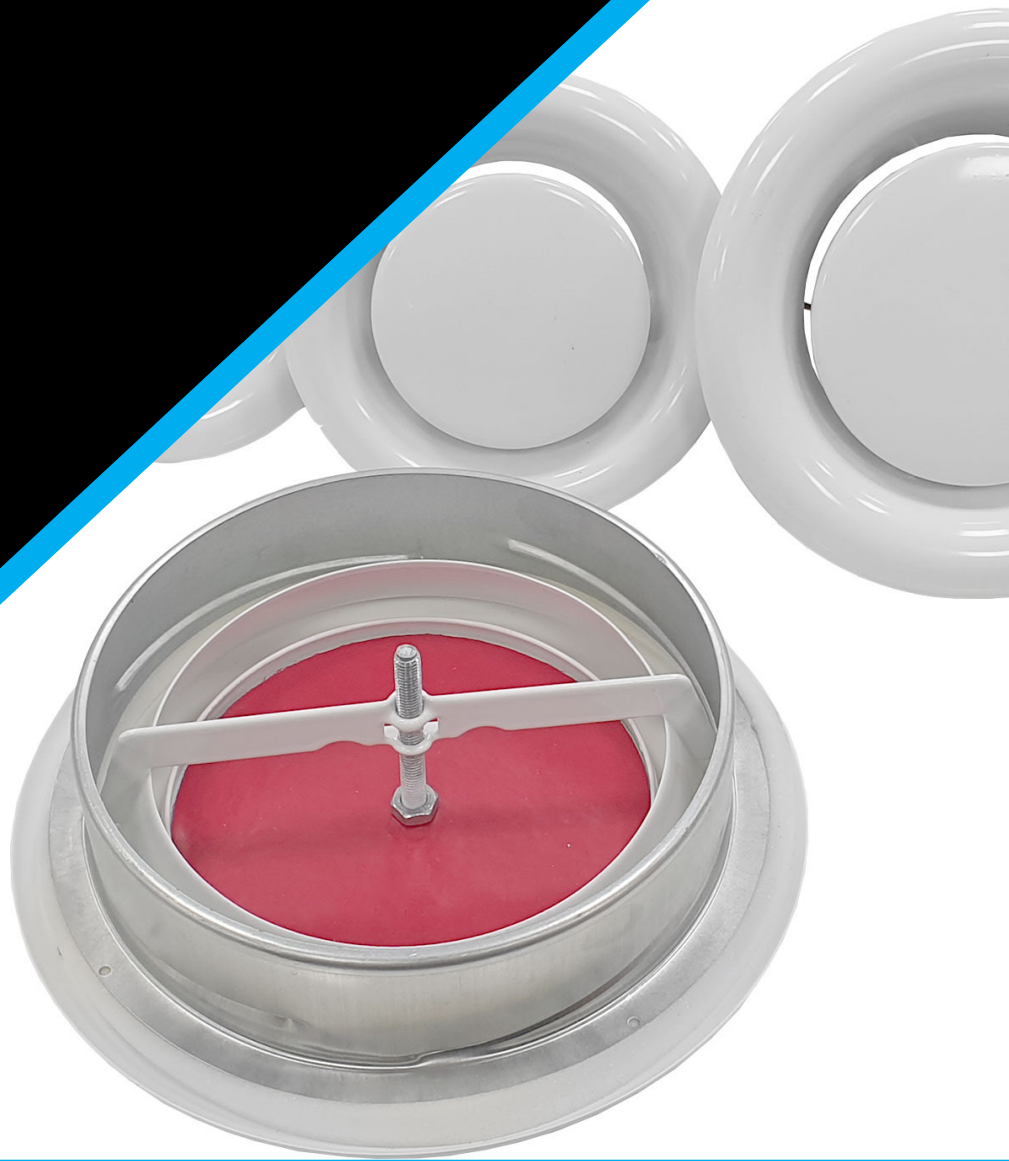

### Astro FR Ceiling Valve Supply

- Suitable for offices, houses, etc. Easy Installation in the ceiling.
- Manufactured from sheet metal painted white RAL 9016
- The valve body is equipped with a cellular plastic gasket.
- The air flow is adjusted by rotating the control disc.
- Supplied with mounting ring.



**Powder Coated finish in RAL 9016**

**Packing: Cardboard box in white.**

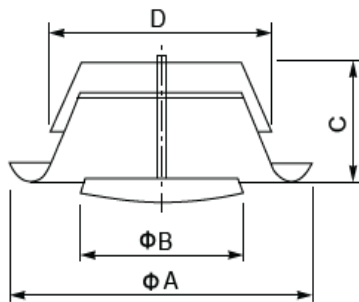

| Extract Valves | A   | B   | C  | D     |  |
|----------------|-----|-----|----|-------|---|
| 80             | 115 | 76  | 42 | 77.5  | 7   |
| 100            | 138 | 92  | 40 | 97.5  | 7   |
| 125            | 164 | 111 | 46 | 122.5 | 7   |
| 150            | 202 | 135 | 50 | 147.5 | 7   |
| 200            | 248 | 194 | 63 | 197.5 | 7   |

**Astro FR Ceiling Valve Supply: Air flow, pressure drop and sound level**

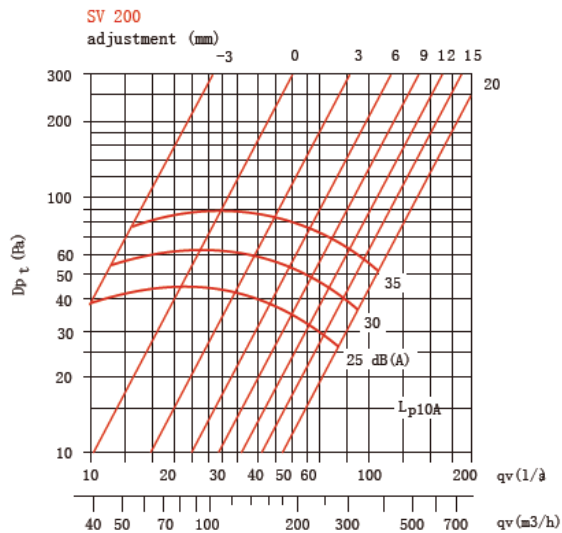
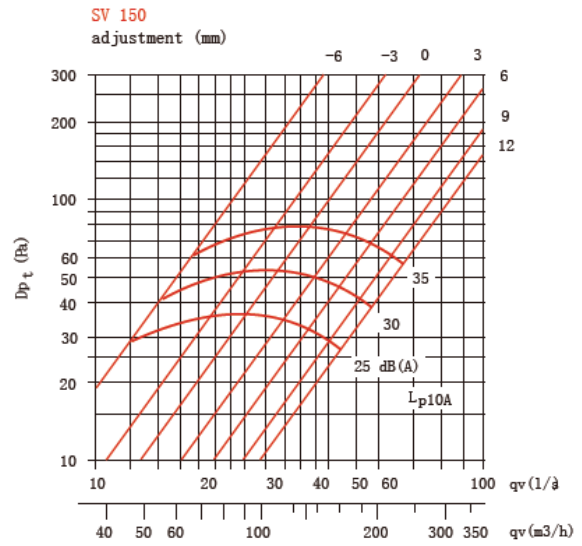
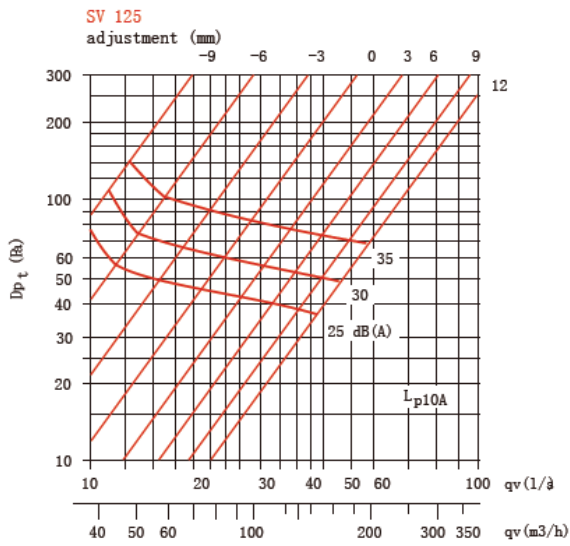
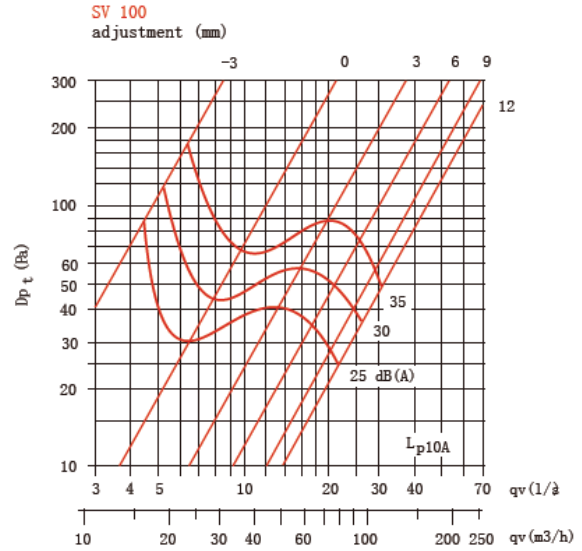
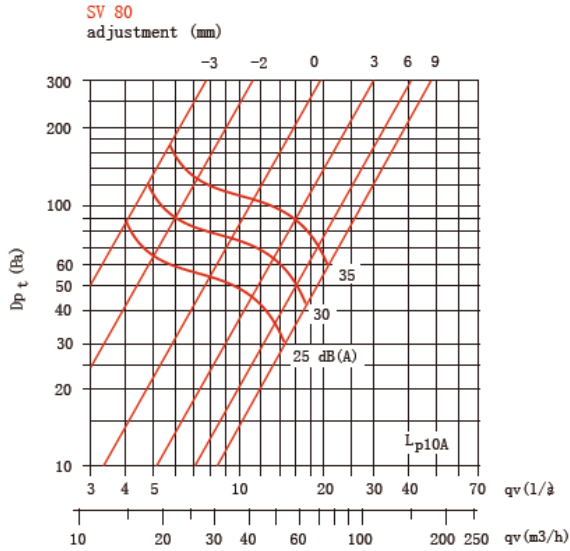

## Installation

We have technical representatives who provide assistance in the selection and specification of the products on this site and should be consulted for exact installation and product suitability. Ensure an early engagement with ourselves, designers, main contractor and specialist installers before any installation. Other trades and/or manufacturers may need to be consulted. For in-depth information, specification and technical advice please call our Head Office on tel [01329 844 500](tel:01329844500) or email [sales@astroflame.com](mailto:sales@astroflame.com)

## Maintenance

All interested parties, designer, specifier, main contractor and specialist installers should provide access to allow the fire stopping seals to be regularly inspected and maintained, as well as records kept of such maintenance at minimum periods of 12 months, as required by the Regulatory Reform Order, and repaired if necessary. Reference should be made to the relevant Code of Practice for the Installation and Inspection of Fire Stopping.

## Competency

It is vital that those entrusted to design or install a fire stopping product have the necessary levels of competence to undertake the task professionally and thoroughly. The level of competency required will be commensurate with the expected complexity of the building. All designers must eliminate, reduce or control foreseeable risks that may arise during installation, construction or maintenance when preparing or modifying designs. Clients should ensure that the principal designer and principal contractor carry out their duties under CDM regulations. The ASFP foundation course in passive fire protection provides essential knowledge as part of demonstrating competency and understanding in this key fire protection specialism.

## Additional Notes

For further information on installation requirements please confirm compatibility with your application, if in doubt please contact the technical team with your ceiling specification on tel [01329 844 500](tel:01329844500) or email [sales@astroflame.com](mailto:sales@astroflame.com)

As part of our policy of ongoing improvements, we reserve the right to modify, alter or change product specifications without giving notice. Product illustrations are representations only. All information contained in this document is provided for guidance only, and as ASTROFLAME (FIRE SEALS) LTD has no control over the specific application or installation methods of the products, or of the prevailing site conditions, no warranties expressed or implied are intended to be given as to the actual performance of the products mentioned or referred to, and no liability whatsoever will be accepted for any loss, damage or injury arising from the use of the information given of products mentioned or referred to herein.

The above information to the best of our knowledge is true and accurate and based upon current test data and is supplied for your guidance only. Customers should satisfy themselves to the suitability of the product based on the products limitation of applications and that the product is fit for purpose for their intended use and no guarantee is given or implied since the conditions of actual use are beyond our control. ASTROFLAME (FIRE SEALS) LTD, disclaim any liability for loss, damage or other expense arising from the use of information, data or products mentioned or referred to and reserve the right to change any details or specifications without notice. If you are in any doubt as to the suitability of this product for your intended application please contact our technical team on 01329 844500 or email [sales@astroflame.com](mailto:sales@astroflame.com) and we will contact you.